

MODULARES
ALTURA DEL PROGRAMA 103 cm.



Modulo 1 pl. P
de 54



Modulo 1 pl. N
de 64



Modulo 1 pl. M
de 74



Modulo 1 pl. G
de 84



Modulo 1 pl. S
de 94

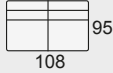

Modulo 2 pl. P
de 54

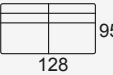

Modulo 2 pl. N
de 64

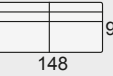

Modulo 2 pl. M
de 74

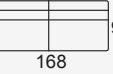

Modulo 2 pl. G
de 84

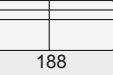

Modulo 2 pl. S
de 94

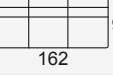

Modulo 3 pl. P
de 54

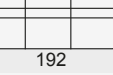

Modulo 3 pl. N
de 64



Brazo PLUS con arcón.
(Izdo. o Dcho.)

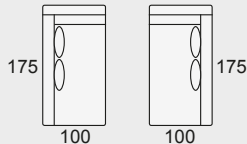

Tumbona
rinconera
de 175x100
(izda. o dcha.)

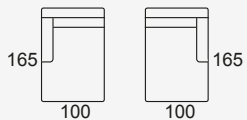

Chaise-longe
de 165x100
(izda. o dcha.)
Brazo con arcón incl.

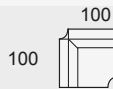

Rinconera recta
de 100 x 100



Mesa rinconera recta
de 100 x 100
con cristal



Puf cuadrado
55x55 cm.

Funda de Puf



Puf chaise-longe
95x55 cm.

Funda de Puf chaise-longe

COMPLEMENTOS (OPCIONALES)

Bluetooth (equipo de sonido)

Enchufe (interior del brazo)



Brazo supletorio central



Cojín rectangular 50x30 cm.



Cojín rectangular 40x25 cm.



Cojín cuadrado 50x50 cm.



Cojín cuadrado 40x40 cm.

SILLÓN Y SOFÁS

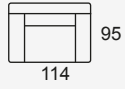

Sillón 1 pl. N
de 64



Sofá 2 pl. P
de 54

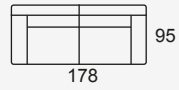

Sofá 2 pl. N
de 64

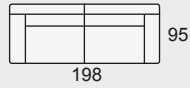

Sofá 2 pl. M
de 74

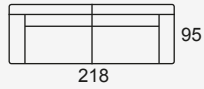

Sofá 2 pl. G
de 84

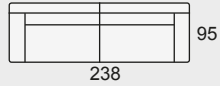

Sofá 2 pl. S
de 94

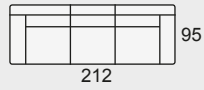

Sofá 3 pl. P
de 54

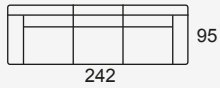

Sofá 3 pl. N
de 64

SOFÁ DE 4 PLAZAS

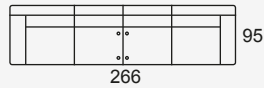

Sofá 4 pl. P
de 54

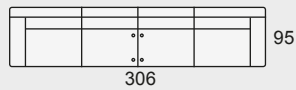

Sofá 4 pl. N
de 64

COMPOSICIONES CON TUMBONA RINCONERA (TUR) IZQUIERDA

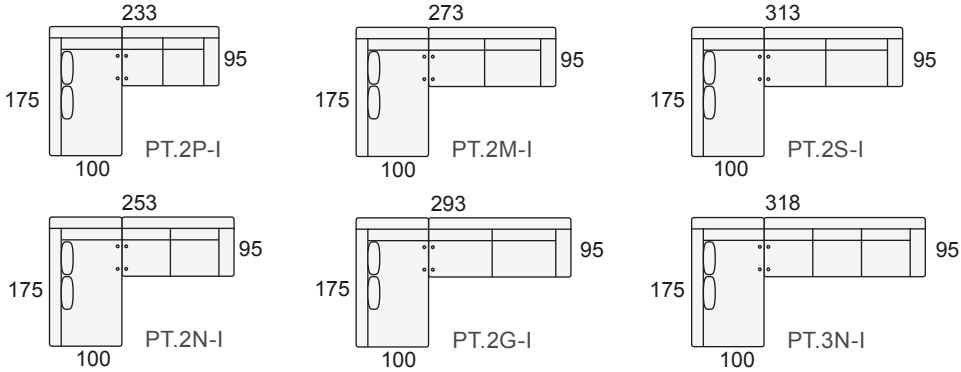

COMPOSICIONES CON TUMBONA RINCONERA (TUR) DERECHA

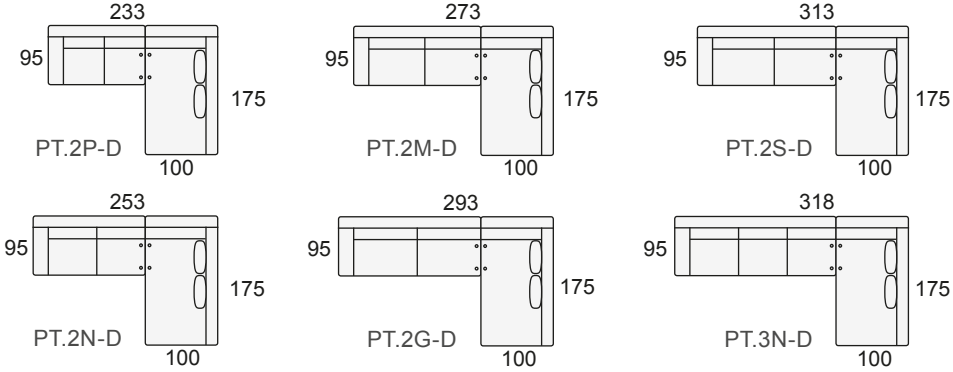

COMPOSICIONES CON CHAISE-LONGE (CHL) IZQUIERDA

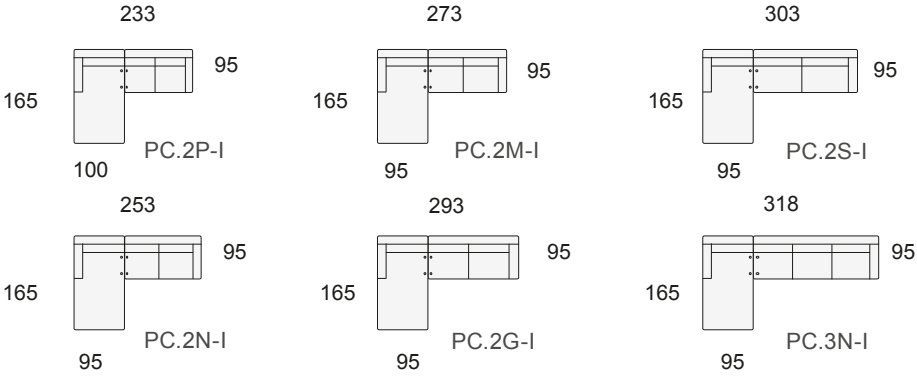

COMPOSICIONES CON CHAISE-LONGE (CHL) DERECHA

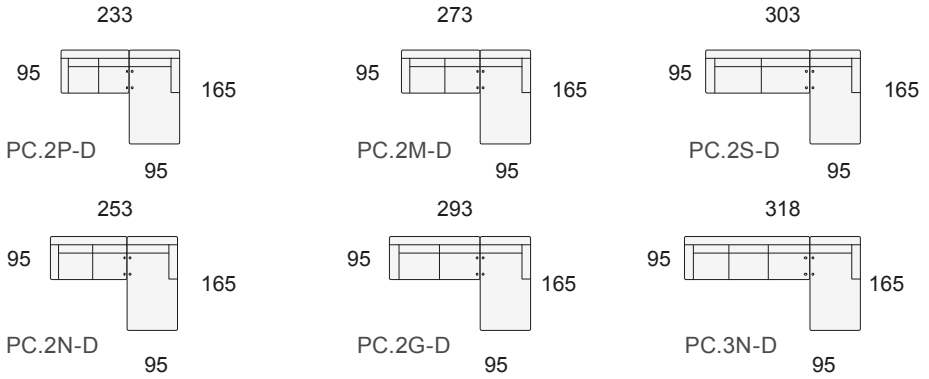

EJEMPLOS DE COMPOSICIONES CON MÓDULO RINCONERA RECTA

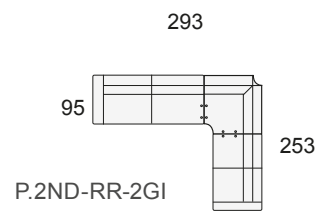
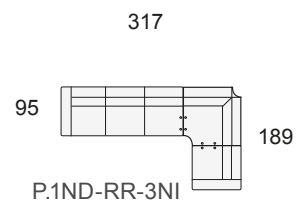
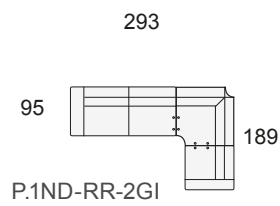
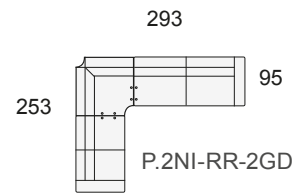
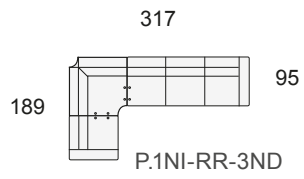
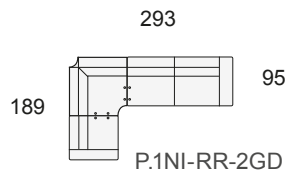

EJEMPLOS DE COMPOSICIONES CON MÓDULO MESA RINCONERA

